



Air diffusion systems

Floor diffuser BZD

Application

The floor diffuser BZD is an air diffuser that can be mounted flush with the floor and be used from low to average temperature differences between supply air and room air.

The diffuser can be used for cooling and heating with a maximum temperature difference of approximately 6 K.

Two types of floor diffusers BZD 200 are available:

BZD is a diffuser for light load, e.g. underneath permanently fixed seats in cinemas, theatres and concert halls. The supply grille, which is the perforated top element of the diffuser, is manufactured from either steel, powder coated (BZD-N) or stainless steel (BZD-E).

BZD + BG incorporates reinforcement for heavy duty («domestic» according to the European standard for static loading criteria) in open floor areas.

Function

The supply air is discharged from the diffuser in eight swirling jets, which flow along the floor.

The air movement is distinguished by a low air velocity without draughts.

The primary induction at the centre point of the diffuser already reduces the temperature difference between supply air and room air as the air is discharged from the diffuser. This primary induction enables the diffuser to operate at a higher temperature difference than is normally possible in the case of floor diffusers.

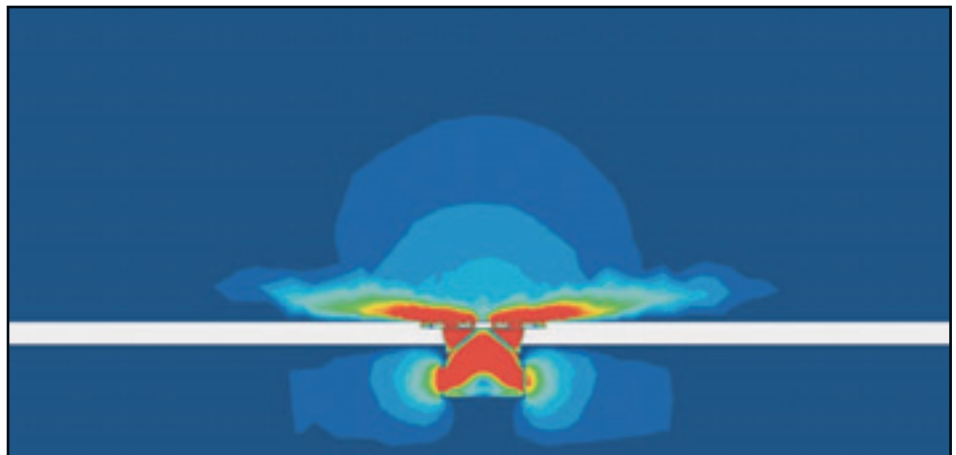
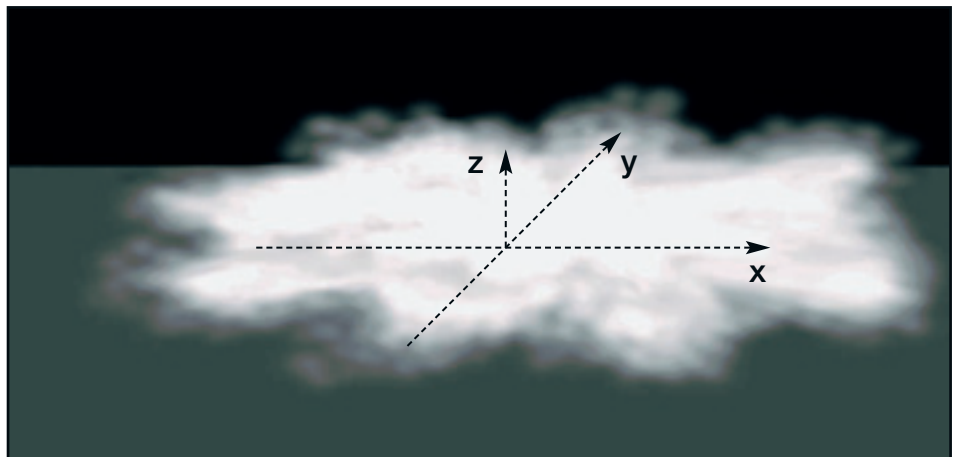

Sizes



BZD 200/125

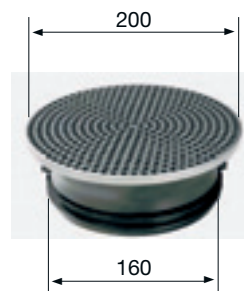

BZD 200/160



BZD 250/225

**Floor diffuser
BZD**

Typical applications

- Museums
- Theatres
- Conference rooms
- Lecture halls
- Lounges

Table of contents

Application, function, sizes 1
 Field of application 2
 BZD 200: Construction, dimensions, components 3
 BZD 250: Construction, dimensions, design and surface treatment 4
 Functional diagram of flow simulation 5
 Decrease in air velocity and temperature difference 6
 Noise level, pressure loss 7
 Installation of standard products 8
 Special solutions 9
 Tender/order form10



Installation of
BZD 200/160 in
wooden floor



Installation of
BZD 200/160 in
stone floor

Museum: Schaulager Münchenstein, Switzerland



Theatre: Olympia, Paris, France



Conference room: Ybl-Palais, Budapest, Hungary



Lounge: Conference centre, Dortmund, Germany

**Floor diffuser
BZD**

BZD 200

**Construction
Dimensions
Components**

Construction BZD 200

The diffuser BZD 200 consists of inlet spigot (1) with integral swirl diffuser (2). The perforated top element is manufactured from steel (3) and is fitted above the swirl diffuser. The heavy duty type incorporates reinforcement (4). The dirt trap manufactured from steel (5) together with the internal control damper can be fastened to the inlet spigot by means of a bayonet look.

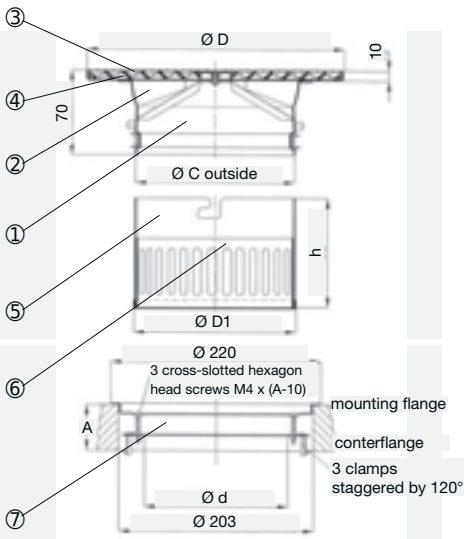

Installation

The diffuser is fitted into raised floors by means of the two-piece back plate **MB** (7), which is fastened to the floor tile with 3 clamps.

For the fitting into stone floors, there is a one-piece back plate manufactured from steel with 3 wall clamps **MR**.

Dimensions BZD 200

| Component | Dimension BZD (mm) | |
|-----------|--------------------|---------|
| | 200/125 | 200/160 |
| D | 198 | 198 |
| C | 123 | 158 |
| D1 | 130 | 165 |
| h | 90 | 125 |
| d | 150 | 170 |

Components BZD 200



Floor diffuser BZD 200
Non-reinforced diffuser

BZD-N (perforated top element of the diffuser manufactured from steel and powder coated)
BZD-E (perforated top element of the diffuser manufactured from stainless steel)

Floor diffuser BZD 200
Reinforced diffuser

BZD-N+BG
BZS-E+BG



Dirt trap
SF



Damper ring
D



Back plate
MB



Back plate with floor clamps
MR



Plenum box
AK

**Floor diffuser
BZD**

**Construction and dimensions
BZD 250/225**

Design of the supply grille

Construction and dimensions BZD 250/225

The construction of size 250 is similar to size 200. However, the dirt trap is fastened to the diffuser with a centre screw. Size 250 has a one-piece back plate with three clamping screws fastened to the floor tile. Custom-made mouting frames are available for special installation situations.

Design and surface treatment of the supply grille

The supply grille, which is the perforated top element of the diffuser, is either powder coated or manufactured from stainless steel (standard). The stainless steel surface can be rolled or treated with glass beads. The perforation of the supply grille can be either 5.5 mm or 4.5 mm in diameter.

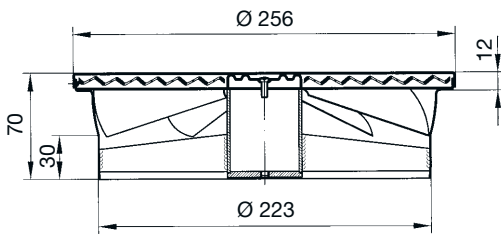

Floor diffuser BZD 250/225

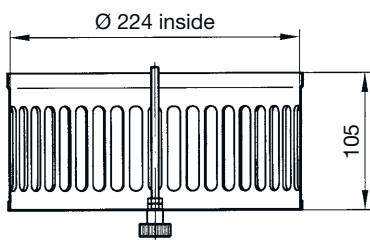

Dirt trap for BZD 250/225

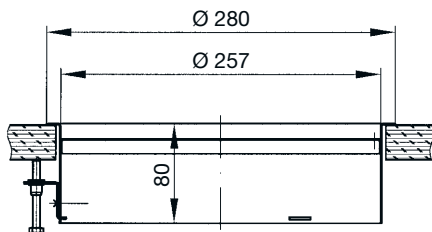

Back plate for BZD 250/225

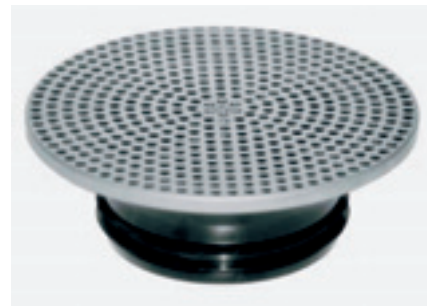

5.5 mm perforated face with centre screw, rolled stainless steel surface

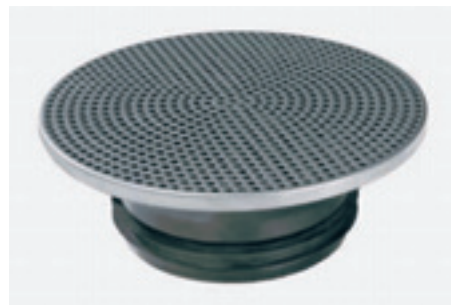

4.5 mm perforated face with clamp fastening at the side

**Floor diffuser
BZD**

Flow simulation

The calculated simulations shown below have been carried out by
GTD GmbH
 Stübelallee 49c
 D-01309 Dresden

GTD is the cooperation partner of Strulik in the field of flow simulation.

**Functional diagram
of flow simulation**

Functional diagram

To represent the function of the floor diffusers type BZD, figure 1 and 2 show the vertical sections for the temperature and velocity distribution for the diffuser BZD 200/125 by calculating the flow simulation.
 Volume flow: 60 m³/h
 Temperature difference supply air/room air: 3 K for cooling

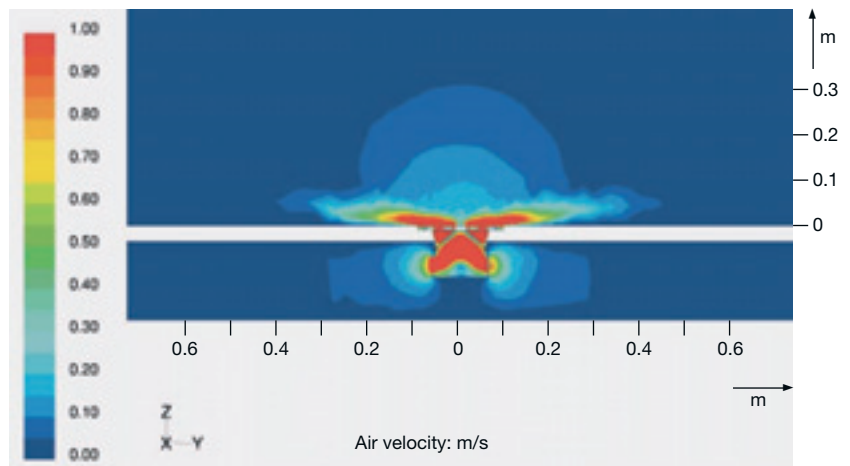

Fig. 1: Vertical section of velocity distribution BZD 200/125
 Volume flow: 60 m³/h, temperature difference: 3 K for cooling

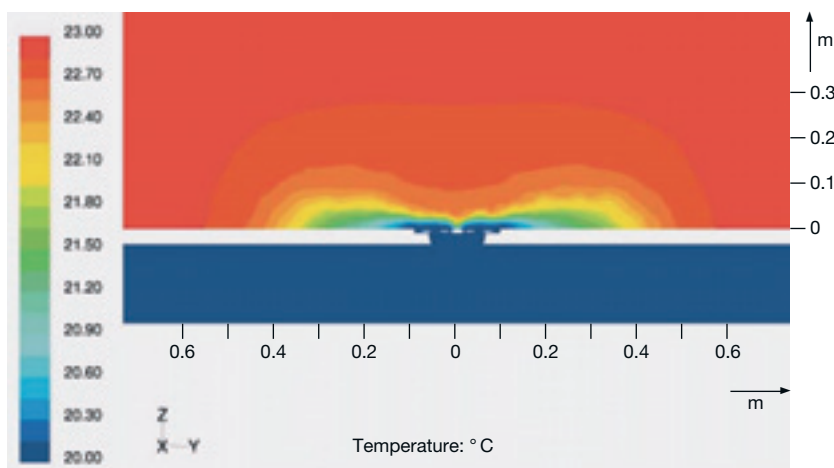

Fig. 2: Vertical section of temperature distribution BZD 200/125
 Volume flow: 60 m³/h, temperature difference: 3 K for cooling

Floor diffuser BZD

Technical data

Air velocities Decrease in temperature difference

Air velocities

The swirling jets of the discharged supply air right above the floor causes a quick reduction of air velocity in the horizontal plain. The maximum air velocities are at a height of 50 mm.

Fig. 3 und 4 show for BZD 200 and BZD 250 the distance, up to which the air velocity at a height of 50 mm is decreased to 0.2 m/s. The values are valid for cooling with 3 K.

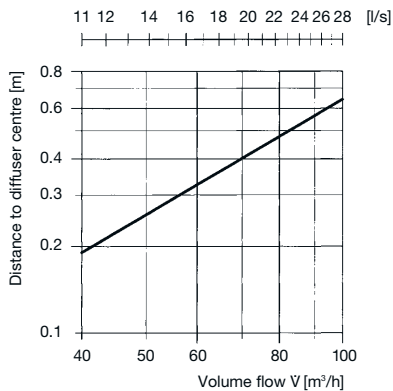

Fig. 3: BZD 200, distance from the centre of the diffuser to the point, at which the air velocity at a height of 50 mm is reduced to 0.2 m/s.

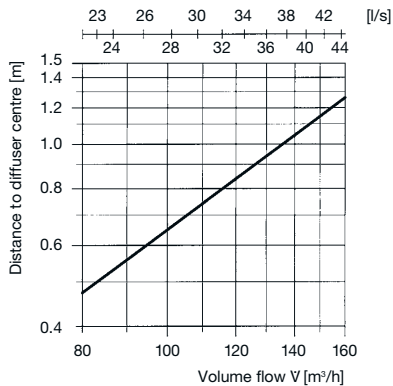

Fig. 4: BZD 250, distance from the centre of the diffuser to the point, at which the air velocity at a height of 50 mm is reduced to 0.2 m/s.

Fig. 5 Local air velocities for BZD 200 at a distance of 450 mm to the centre of the diffuser for volume flows from 30 to 60 m³/h with also 3 K for cooling.

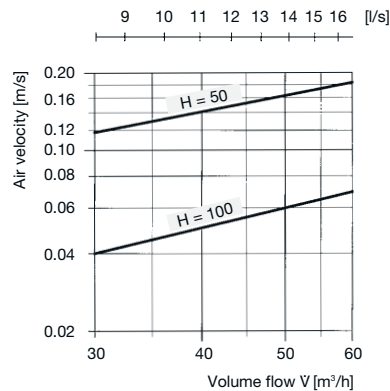

Fig. 5: BZD 200, local air velocity at a distance of 450 mm from the centre of the diffuser for volume flows from 30 to 60 m³/h.

Decrease in temperature difference supply air/room air

Fig. 6 The rapid reduction in temperature difference and percentage decrease of the temperature difference supply air/room air for BZD 200 for volume flows between 40 and 80 m³/h across the distance from the centre of the diffuser. The values are valid for temperature difference between 2 and 4 K.

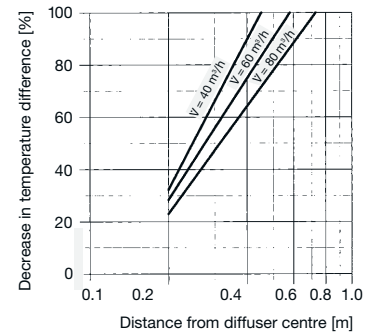

Fig. 6: BZD 200, percentage reduction of the temperature difference supply air/room air across the distance from the centre of the diffuser.

**Floor diffuser
BZD**

Technical data

**Noise level
Pressure loss**

Noise level and pressure loss

The noise level in dB(A) and pressure loss in Pa are shown in **figures 7 to 9**.

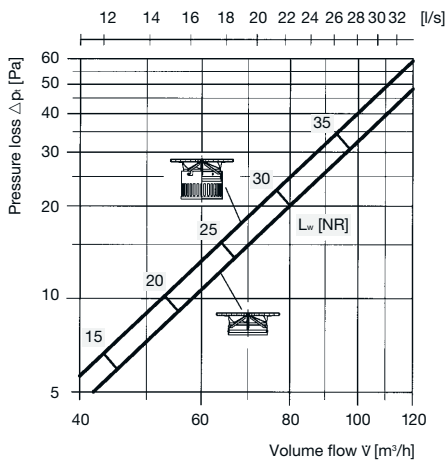

Fig. 7: BZD 200/125, pressure loss and noise level

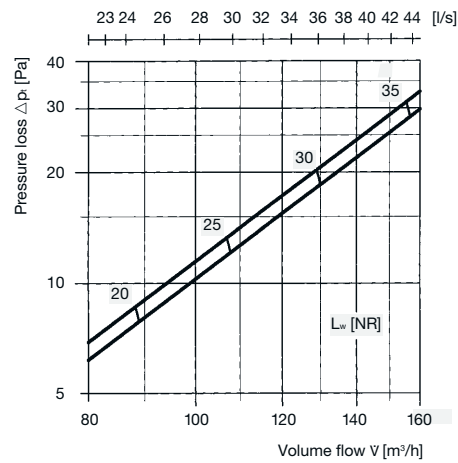

Fig. 9: BZD 250/225, pressure loss and noise level

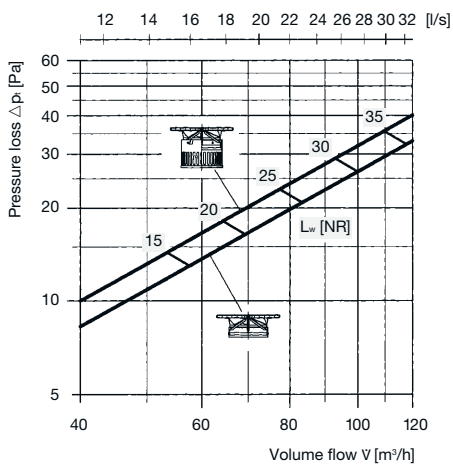
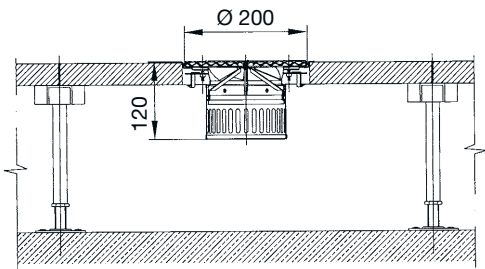

Fig. 8: BZD 200/160, pressure loss and noise level

**Floor diffuser
BZD**

Installation situations

**Standard product
Variations**



Installation into raised floors: Air supply via raised floor plenum

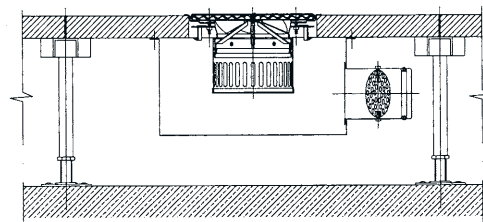

Installation into raised floors: Air supply via individual connection with plenum box

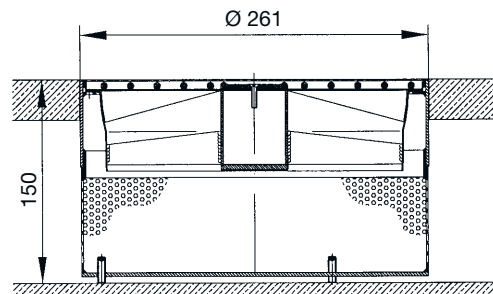
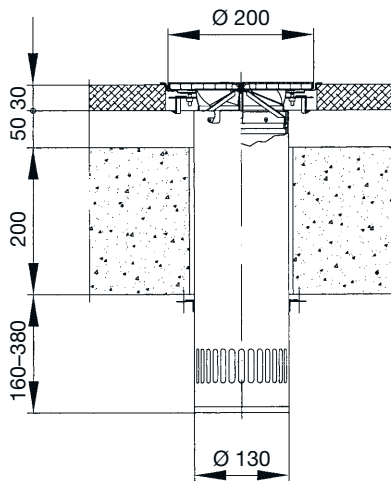

Special BZD 250 for a low noise level with special mounting frame
(Fondazione Prada, New York, USA)

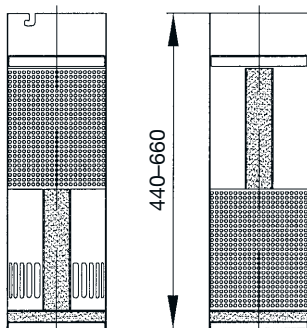

Special BZD with long dirt trap and acoustic chamber
(Olympia, Paris, France)

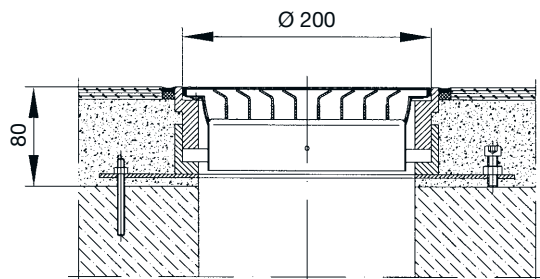

Special BZD for heavy duty and low noise level with special mounting frame
(Schaulager, Münchenstein, Switzerland)

**Floor diffuser
BZD**

**Examples
of special solutions**

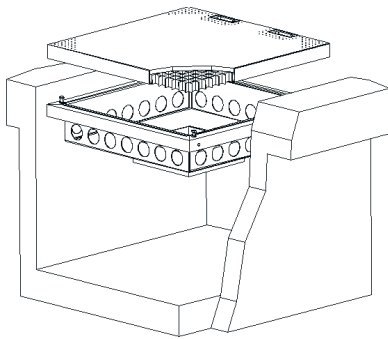

Heavy duty floor diffuser with **wooden covering** (630 x 630 mm), dirt trap and electric box for media connection. Installation within concrete shaft.

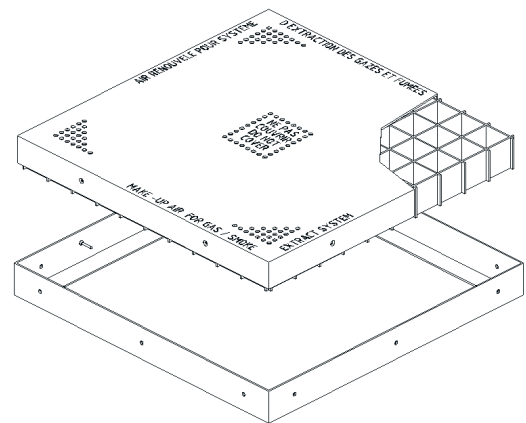

Exhaust air device with engraved and perforated top element (400 x 400 mm) manufactured from stainless steel.

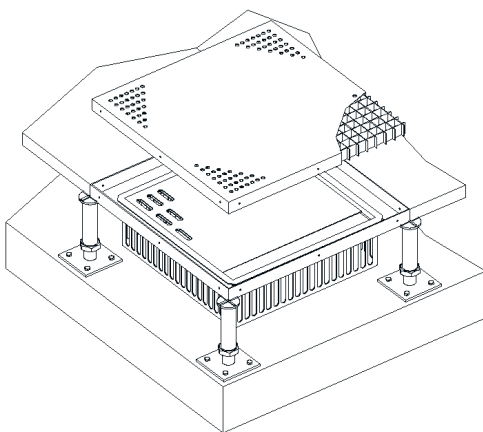

Floor diffuser with bar grate substructure and perforated top element manufactured from stainless steel to fit as insertion module for raised floors (600 x 600 mm).

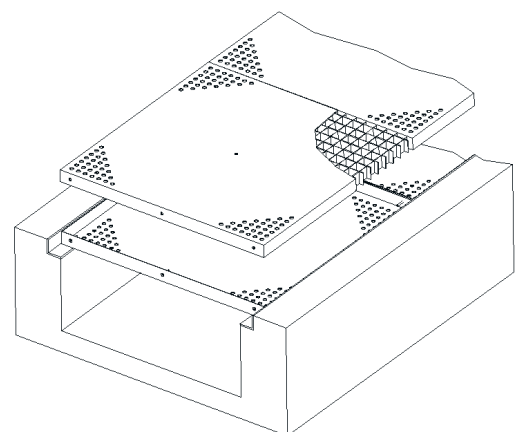

Floor diffuser with bar grate substructure as insertion module in concrete shaft. Perforated top element manufactured from steel.

Tender / Order Form BZD

| Item | Description | Units Pieces | Unit price | Total |
|------|--|-----------------|------------|-------|
| | <p>Strulik floor diffuser BZD for draught-free introduction of supply air at floor level. Diffuser consisting of a swirl element with supply grille of perforated plate, optionally as step-on diffuser with reinforcement, dirt trap with damper for volume flow adjustment. Incorporated into raised floor with two-piece mounting back plate. Air fed via raised floor or plenum box. Swirl element, dirt trap and damper are manufactured of sheet steel and afterwards coated RAL 9005 mat. The plenum box is manufactured of zinc-plated steel.</p> <p>Size:</p> <p><input type="checkbox"/> BZD 200/125</p> <p><input type="checkbox"/> BZD 200/160</p> <p><input type="checkbox"/> BZD 250/225</p> <p>Supply grille:</p> <p><input type="checkbox"/> Perforated plate, stainless steel (BZD-E)</p> <p><input type="checkbox"/> Sheet steel, powder coated to RAL (BZD-N)</p> <p><input type="checkbox"/> Fastening via centre screw</p> <p><input type="checkbox"/> Clamp fastening at rim</p> <p>Accessoires:</p> <p><input type="checkbox"/> Reinforcement for light load (domestic) (BG)</p> <p><input type="checkbox"/> Back plate (MR)</p> <p style="padding-left: 20px;"><input type="checkbox"/> Viewing side of stainless steel</p> <p style="padding-left: 20px;"><input type="checkbox"/> Zinc-plated steel</p> <p style="padding-left: 20px;"><input type="checkbox"/> Sheet steel coated to RAL</p> <p><input type="checkbox"/> Dirt trap (SF)</p> <p><input type="checkbox"/> Damper (D)</p> <p><input type="checkbox"/> Back plate with wall clamps (MR)</p> <p><input type="checkbox"/> Plenum box (AK)</p> <p>Volume flow: m³/h</p> <p>Maximum noise level: db(A)</p> <p>Maximum pressure loss: Pa</p> <p>Manufacturer: Strulik</p> <p>Type: BZD</p> <p>Product: Floor diffuser</p> | | | |